



**Cherokee  
By Choice**



**CHEROKEE** | **ECONOMIC**  
OFFICE OF | **DEVELOPMENT**

# Coloring Book

Presented By **CHEROKEE** OFFICE OF **ECONOMIC DEVELOPMENT**  
[cherokeega.org](http://cherokeega.org)

## Color and Share

Reveal your masterpieces on  
social media using the hashtag  
**#cherokeebychoice**

Featured on the cover of Southern Living Magazine and located in the Ball Ground area, Gibbs Gardens is one of Georgia’s most breathtaking tourist attractions.

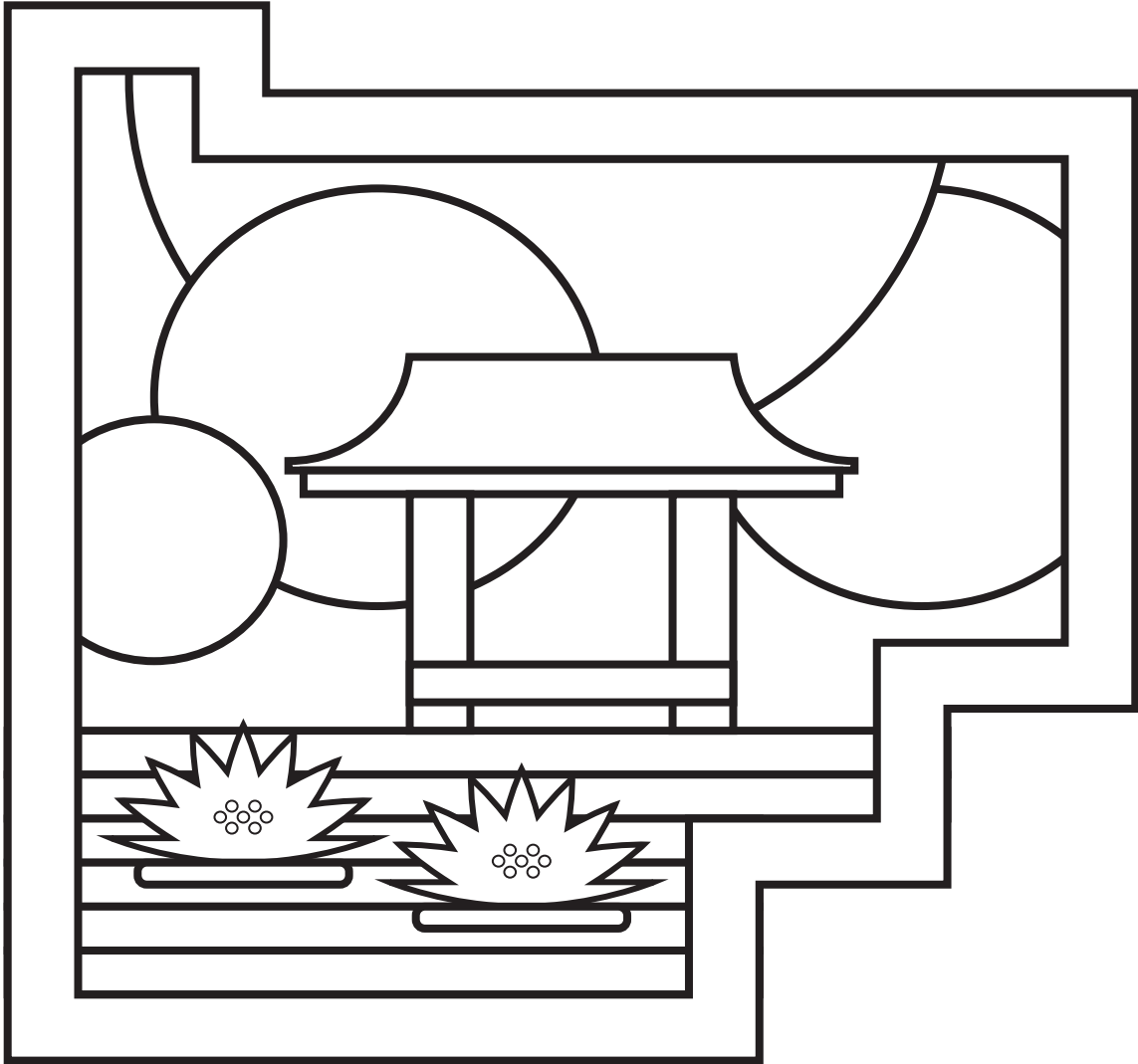

**GIBBS GARDENS | BALL GROUND**

**Color and Share**

Reveal your masterpieces on social media using the hashtag **#cherokeebychoice**

Presented By **CHEROKEE OFFICE OF ECONOMIC DEVELOPMENT** | [cherokeega.org](http://cherokeega.org)

The Greenprints Trail System is a series of multi-use trails that run throughout the City of Woodstock, offering the perfect place to exercise and enjoy the great outdoors.

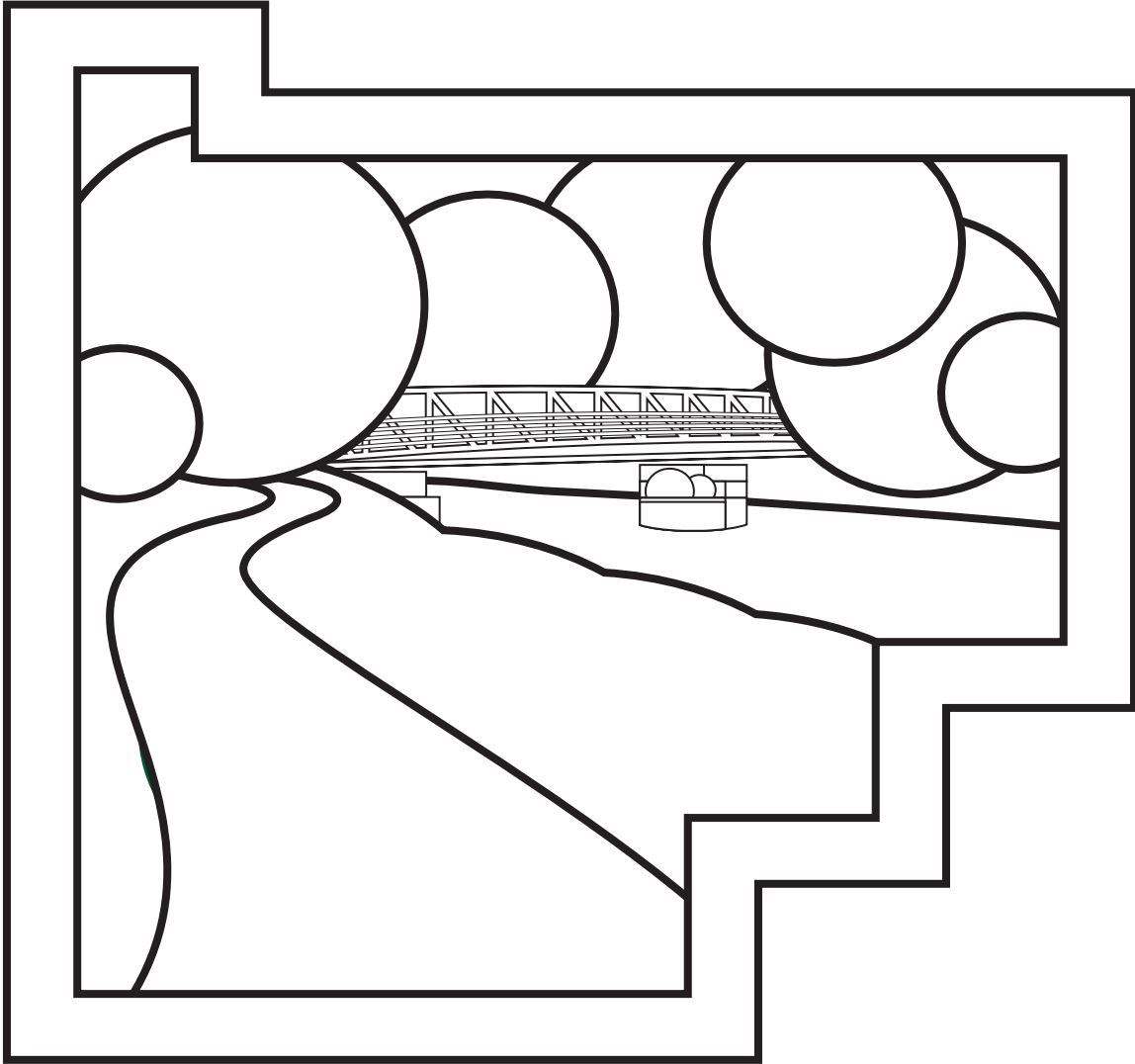

## GREENPRINTS TRAIL SYSTEM | WOODSTOCK

### Color and Share

Reveal your masterpieces on social media using the hashtag **#cherokeebychoice**

Presented By **CHEROKEE OFFICE OF ECONOMIC DEVELOPMENT** | [cherokeega.org](http://cherokeega.org)

The Cherokee County Regional Airport is a premier business and recreational aviation facility and is home to one of the largest based aircraft fleets in Georgia.

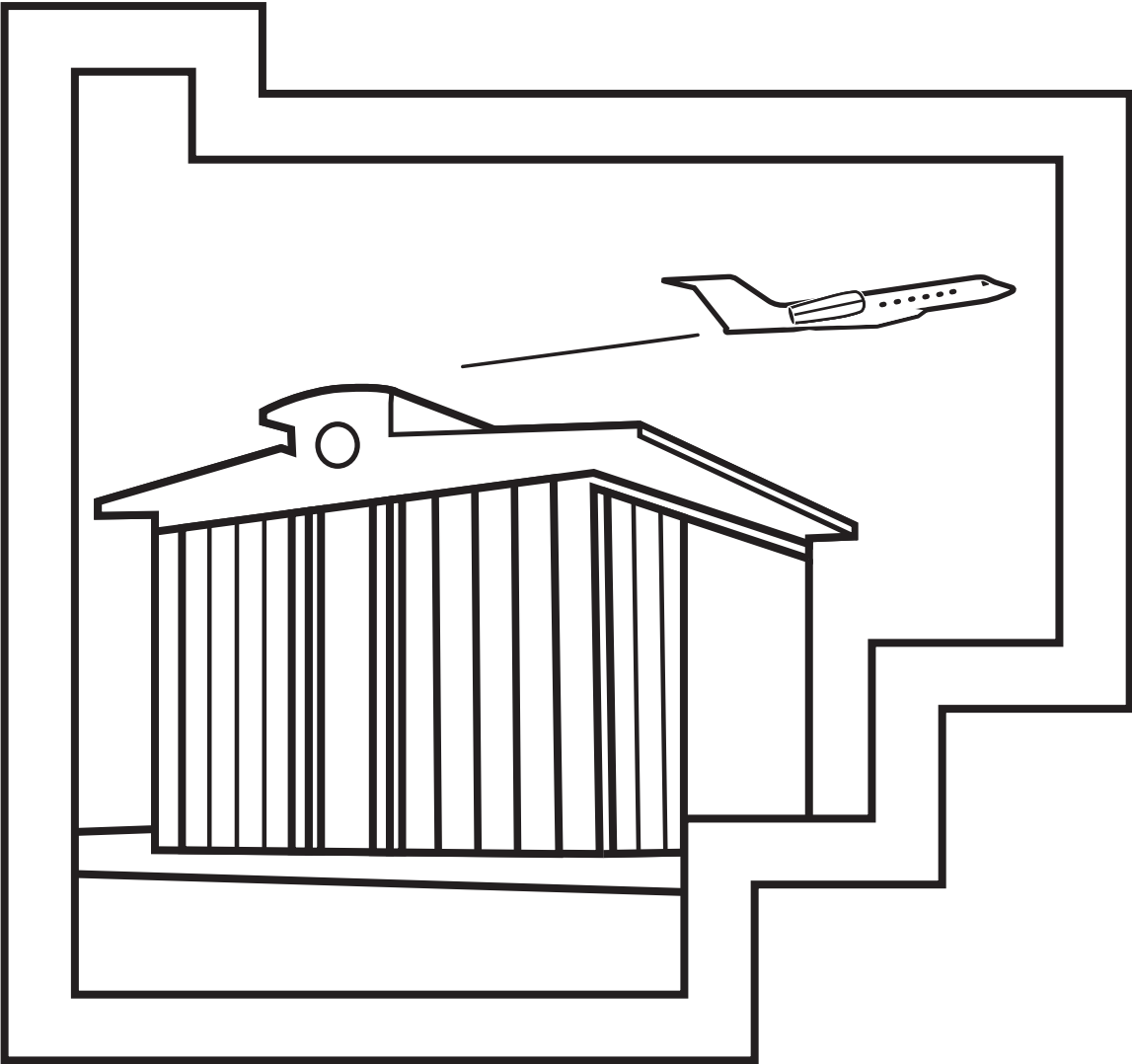

**CHEROKEE REGIONAL AIRPORT | BALL GROUND**

**Color and Share**

Reveal your masterpieces on social media using the hashtag **#cherokeebychoice**

Presented By **CHEROKEE OFFICE OF ECONOMIC DEVELOPMENT** | [cherokeega.org](http://cherokeega.org)

If you're looking for a budget-friendly sport that everyone in the family can enjoy, the Atlanta Yacht Club can welcome you to the world of inland sailing on Lake Allatoona.

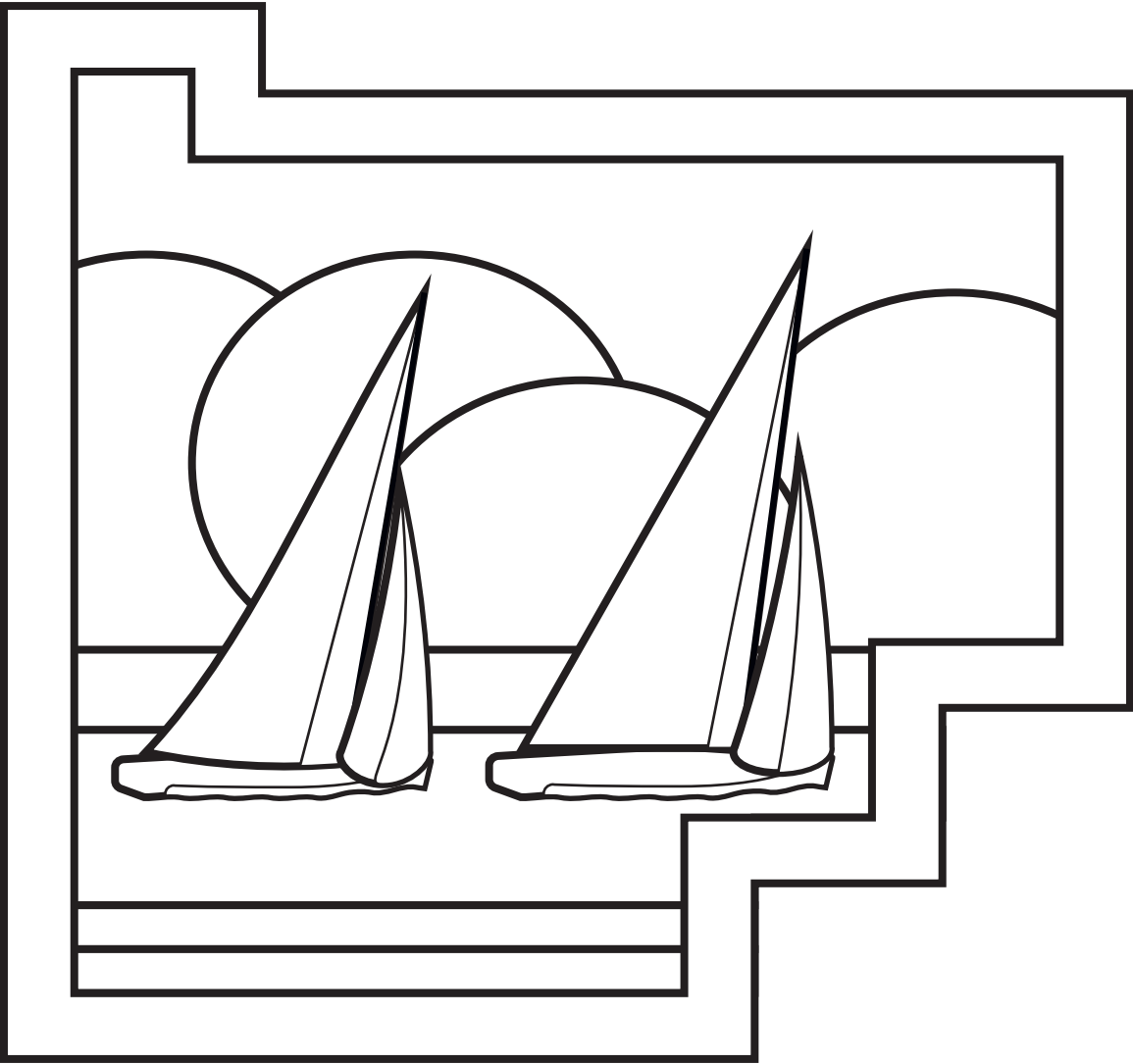

**ATLANTA YACHT CLUB | LAKE ALLATOONA**

**Color and Share**

Reveal your masterpieces on social media using the hashtag **#cherokeebychoice**

Presented By **CHEROKEE OFFICE OF ECONOMIC DEVELOPMENT** | [cherokeega.org](http://cherokeega.org)

Located in the Historic Woodstock Elementary basketball gym, The Circuit is Chattahoochee Tech’s Student Center and Cherokee’s first coworking space. Visit this Downtown Woodstock icon and grab a cup of Joe in The Circuit from locally owned Alma Coffee.

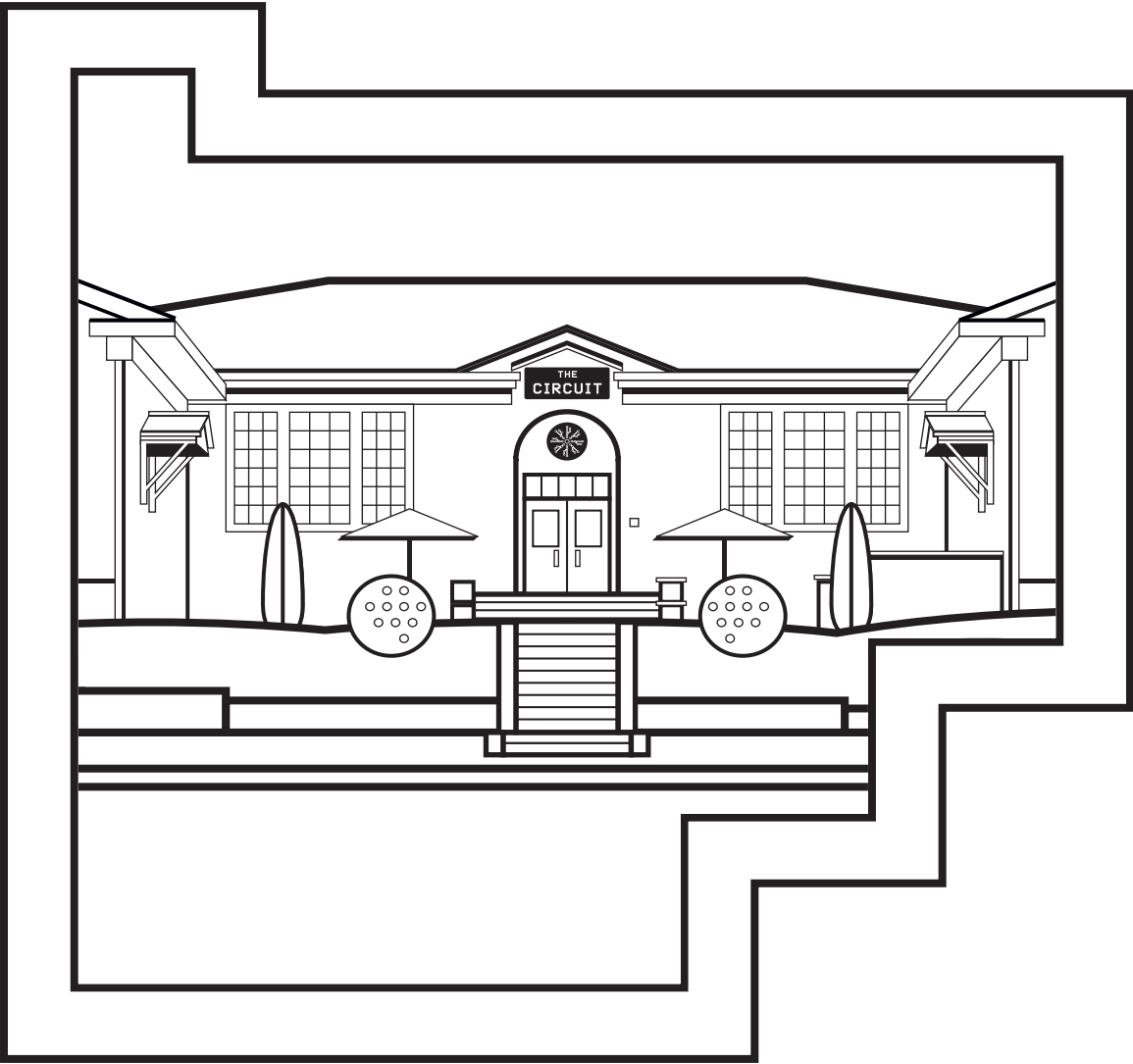

## THE CIRCUIT | WOODSTOCK

### Color and Share

Reveal your masterpieces on social media using the hashtag **#cherokeebychoice**

Presented By **CHEROKEE OFFICE OF ECONOMIC DEVELOPMENT** | [cherokeega.org](http://cherokeega.org)

The Cherokee Aquatic Center is a full-service aquatics center with two indoor pools and one outdoor leisure pool offering competitive, fitness, instructional, therapeutic, and recreational swimming opportunities for kids and adults.

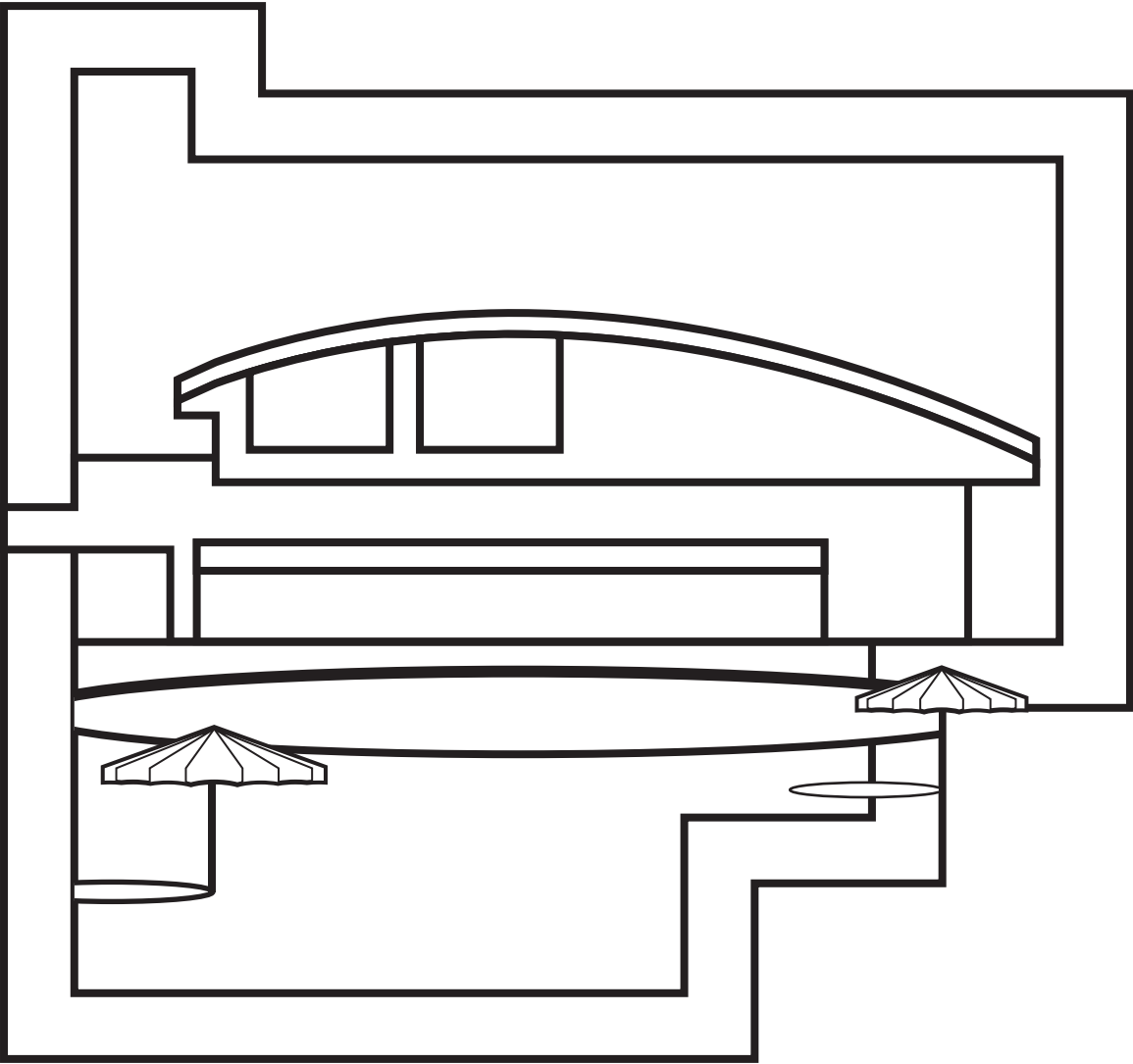

## CHEROKEE AQUATIC CENTER | HOLLY SPRINGS

### Color and Share

Reveal your masterpieces on social media using the hashtag **#cherokeebychoice**

Presented By **CHEROKEE OFFICE OF ECONOMIC DEVELOPMENT** | [cherokeega.org](http://cherokeega.org)

# Cherokee

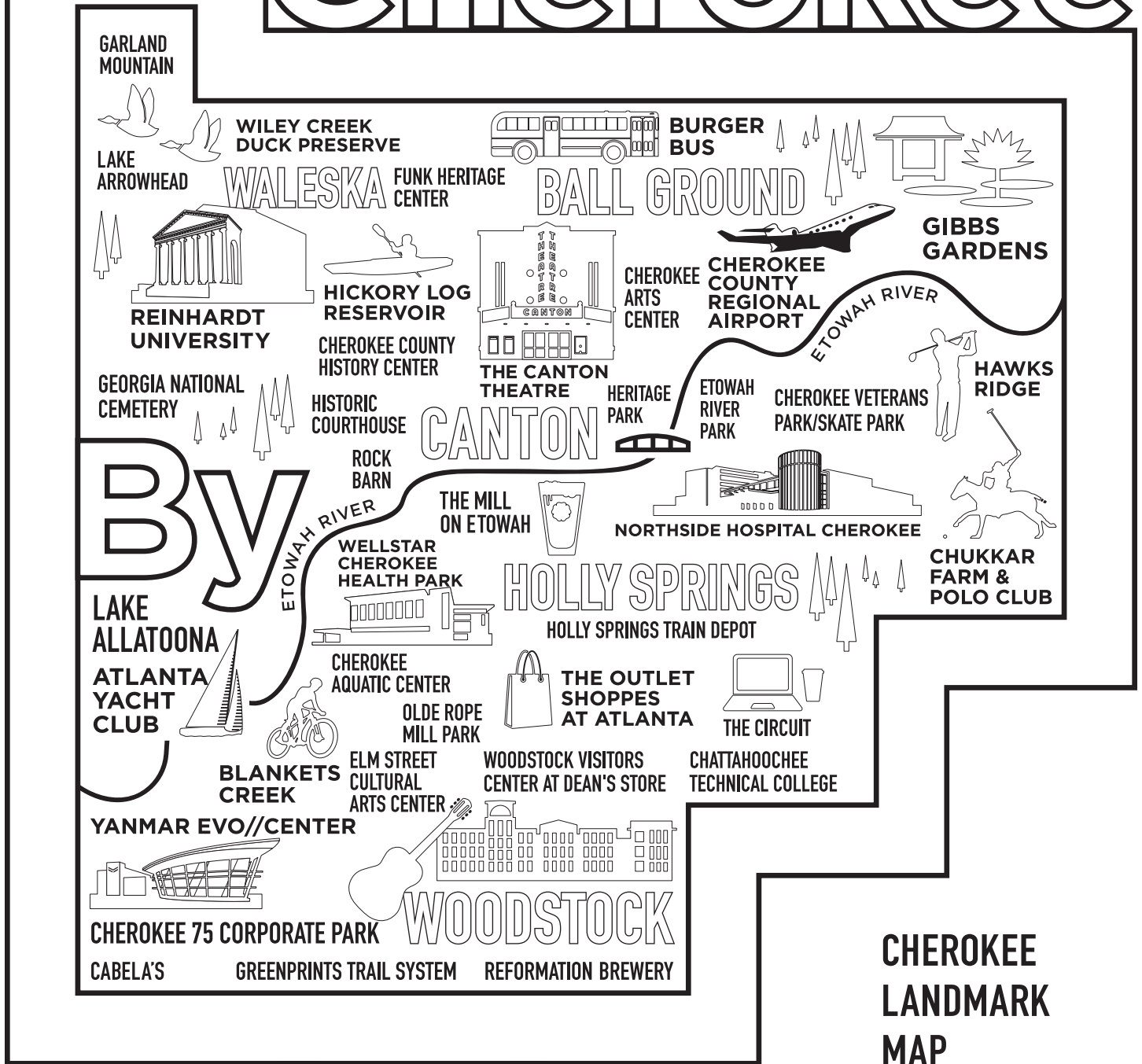

**CHEROKEE  
LANDMARK  
MAP**

# Choice

## Color and Share

Reveal your masterpieces on social media using the hashtag **#cherokeebychoice**

Presented By **CHEROKEE OFFICE OF ECONOMIC DEVELOPMENT** | [cherokeega.org](http://cherokeega.org)



Located in Historic Downtown Ball Ground and featured in a recent Disney+ movie *Timmy Failure*, the Burger Bus is a one-of-a-kind, local family-owned restaurant inside a repurposed Atlanta transit bus.

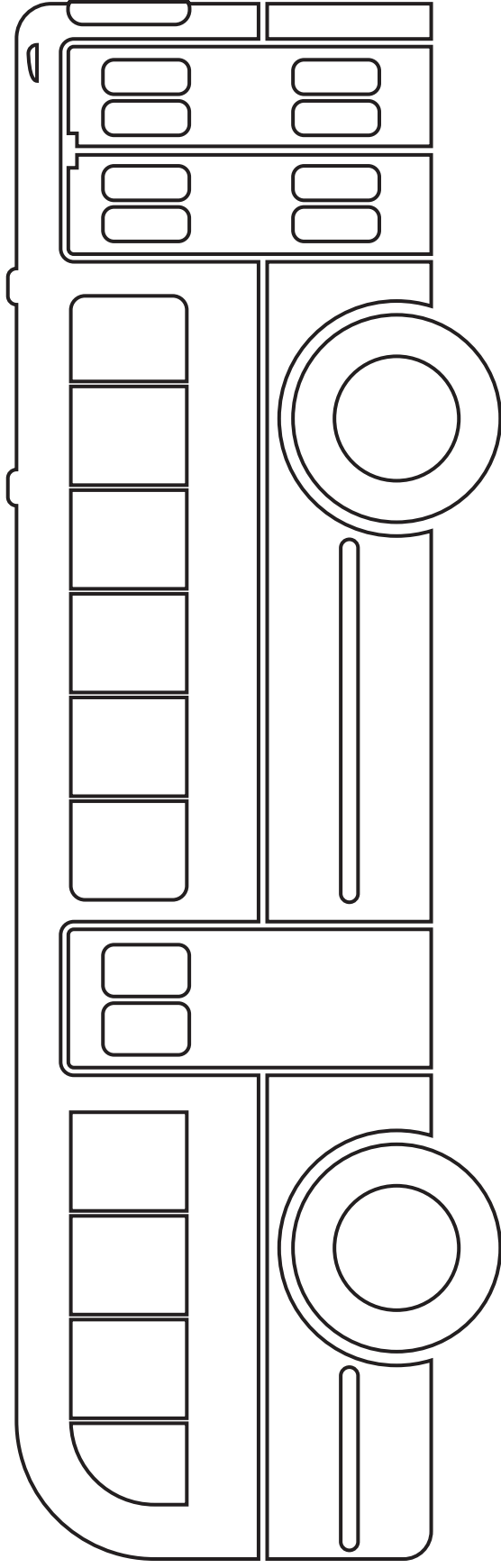

## **BALL GROUND BURGER BUS**

### **Color and Share**

Reveal your masterpieces on social media using the hashtag **#cherokeebychoice**

Presented By **CHEROKEE OFFICE OF ECONOMIC DEVELOPMENT** | [cherokeega.org](http://cherokeega.org)

The “Live in and Love Woodstock” Guitar Sculpture is located on the Elm Street Green and accessible via the Greenprints Trail System. It is open year-round for photo opportunities.

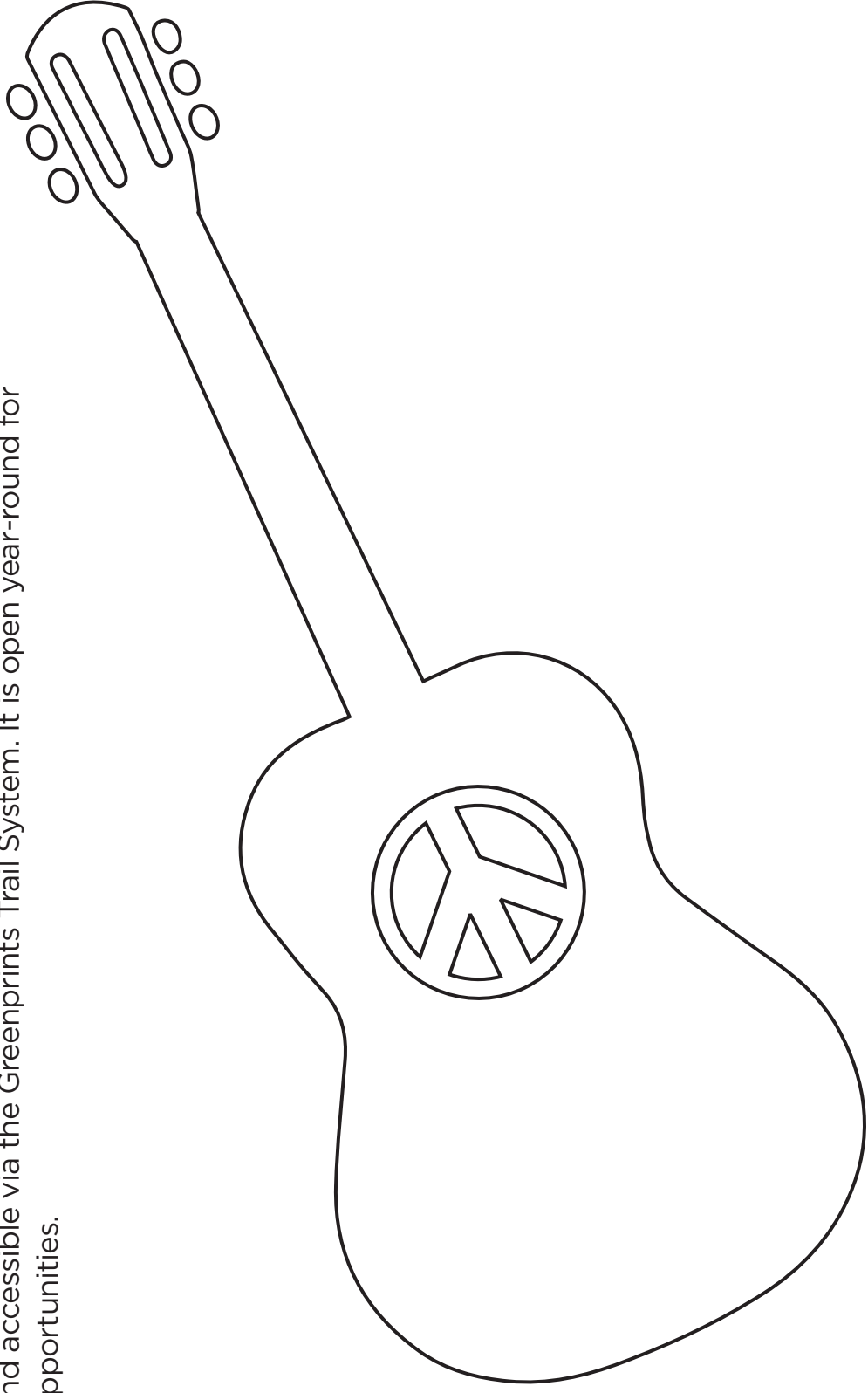

## “LIVE IN AND LOVE WOODSTOCK” GUITAR SCULPTURE | DOWNTOWN WOODSTOCK

Artist: Diedra Smith

### Color and Share

Reveal your masterpieces on social media using the hashtag **#cherokeebychoice**

Presented By **CHEROKEE OFFICE OF ECONOMIC DEVELOPMENT** | [cherokeega.org](http://cherokeega.org)

For over 100 years, the iconic Canton Theatre has marked Downtown Canton's historic landscape. The theatre continues to bring the community together for film, live theatre, concerts, and special events.

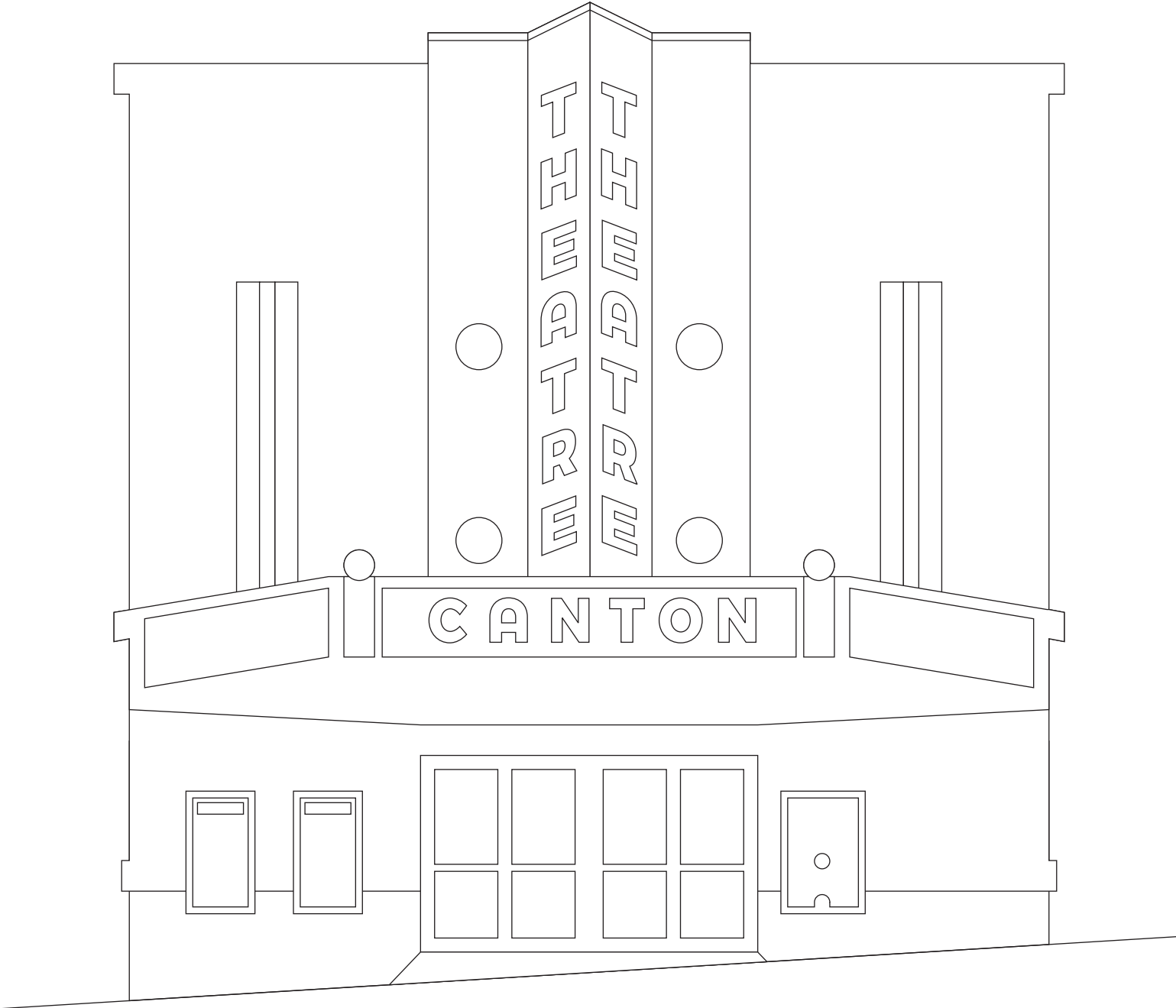

# CANTON THEATRE

## Color and Share

Reveal your masterpieces on social media using the hashtag **#cherokeebychoice**

Presented By **CHEROKEE OFFICE OF ECONOMIC DEVELOPMENT** | [cherokeega.org](http://cherokeega.org)



Downtown Woodstock – one of Georgia’s premier travel destinations – offers an amazing variety of entertainment, chef-driven restaurants, unique shops, parks, trails, and places to explore.

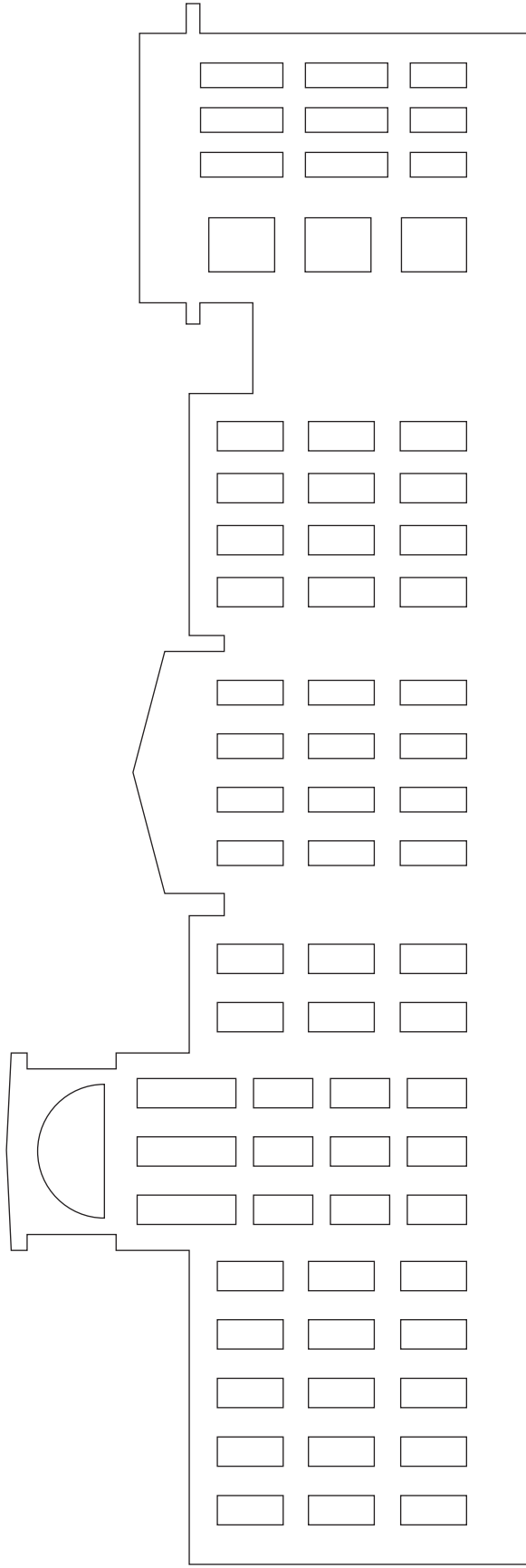

## **DOWNTOWN WOODSTOCK | A CITY UNEXPECTED**

### **Color and Share**

Reveal your masterpieces on social media using the hashtag **#cherokeebychoice**

Presented By **CHEROKEE OFFICE OF ECONOMIC DEVELOPMENT** | [cherokeega.org](http://cherokeega.org)



WellStar Health System, known nationally for its innovative care models, opened this four-story health park in 2019 - offering a variety of medical specialties all in a single location.

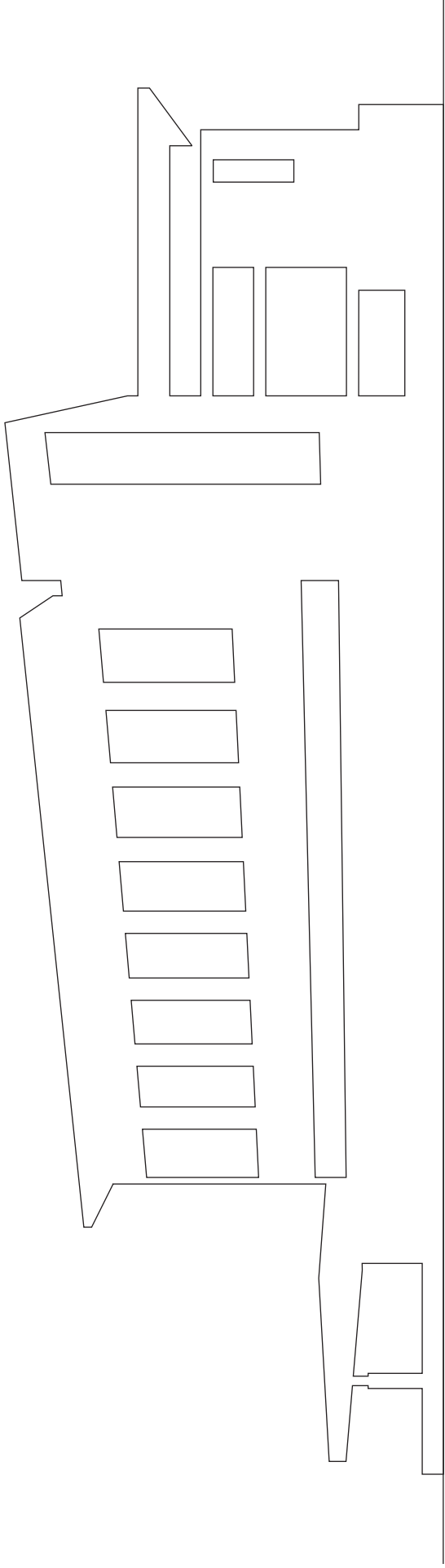

## WELLSTAR CHEROKEE HEALTH PARK AT HOLLY SPRINGS

### Color and Share

Reveal your masterpieces on social media using the hashtag **#cherokeebychoice**

Presented By CHEROKEE OFFICE OF ECONOMIC DEVELOPMENT | [cherokeega.org](http://cherokeega.org)



**NORTHSIDE HOSPITAL  
CHEROKEE**

Northside Hospital Cherokee is an award-winning full-service regional hospital located on a state-of-the-art campus overlooking beautiful Canton Creek and I-575 in Canton.

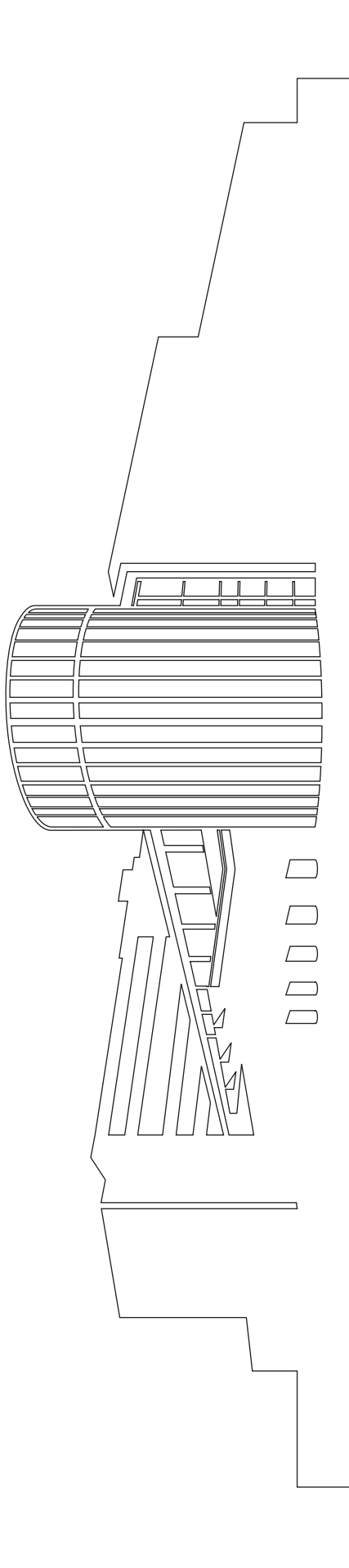

**NORTHSIDE HOSPITAL CHEROKEE | CANTON**

**Color and Share**

Reveal your masterpieces on social media using the hashtag **#cherokeebychoice**

Presented By **CHEROKEE OFFICE OF ECONOMIC DEVELOPMENT** | [cherokeega.org](http://cherokeega.org)



Located in southwest Cherokee, this innovative facility focuses on sustainability, education, and community engagement. Visitors can gain hands-on experience on a variety of YANMAR tractors and UTVs through an interactive showroom and on-site demonstrations.

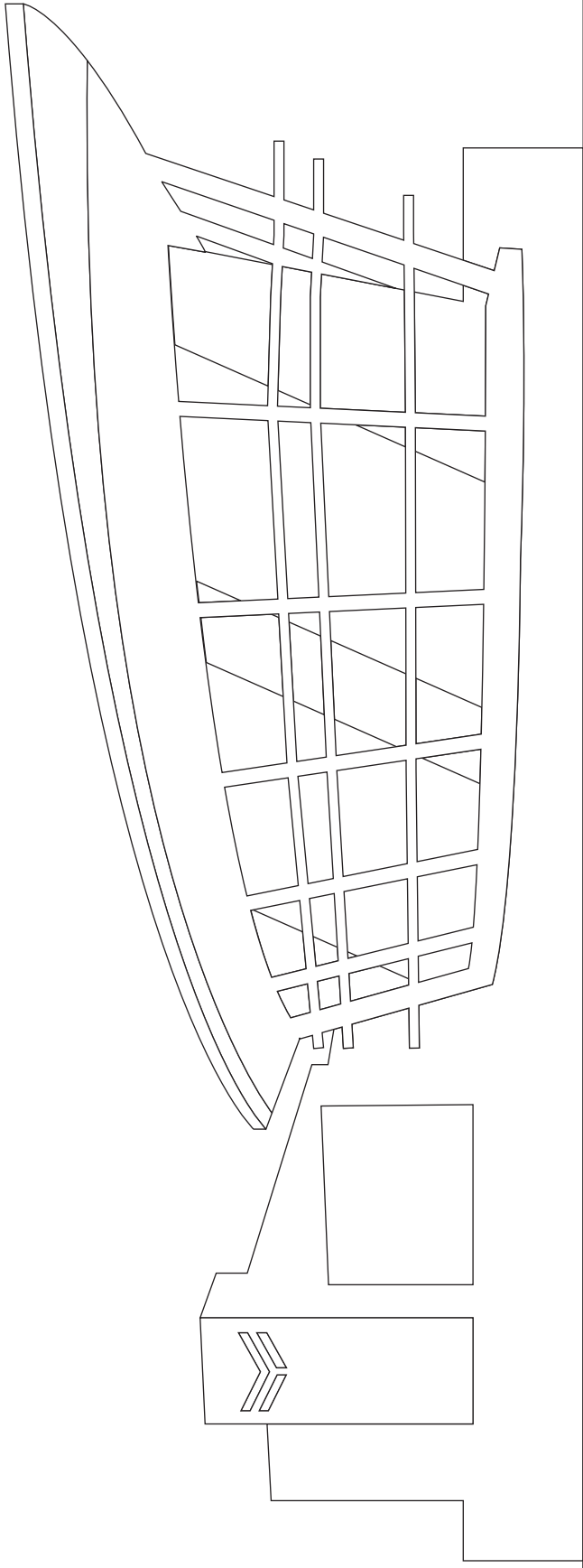

## YANMAR EVO//CENTER

### Color and Share

Reveal your masterpieces on social media using the hashtag **#cherokeebychoice**

Presented By **CHEROKEE OFFICE OF ECONOMIC DEVELOPMENT** | [cherokeega.org](http://cherokeega.org)



Reinhardt University's scenic 525-acre campus features lush trees, cascading ponds, hiking & biking trails and so much more. Reinhardt offers 40+ undergraduate programs, four graduate programs, and 23 sports programs.

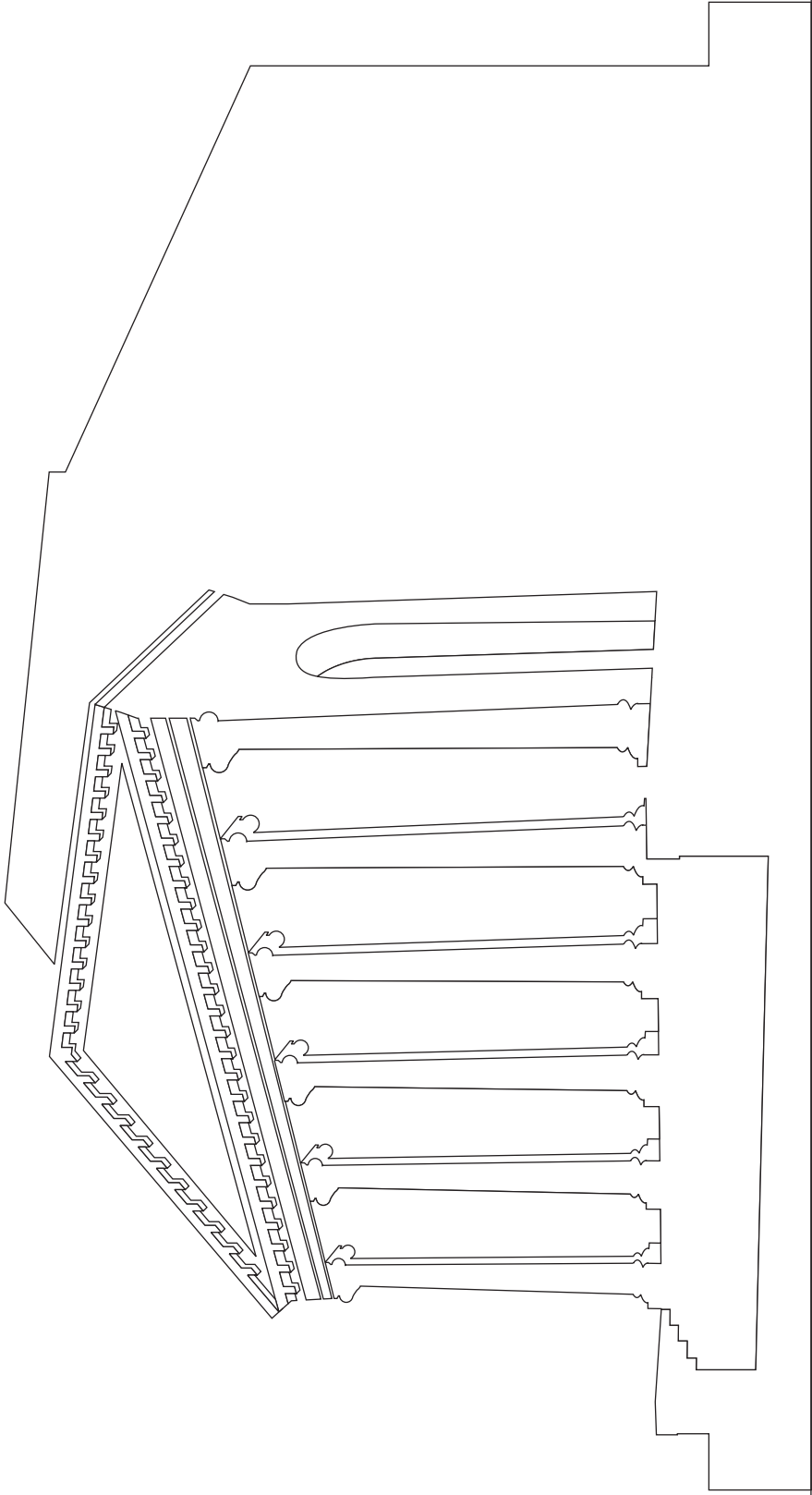

## REINHARDT COLLEGE | WALESKA

### Color and Share

Reveal your masterpieces on social media using the hashtag **#cherokeebychoice**

Presented By **CHEROKEE OFFICE OF ECONOMIC DEVELOPMENT** | [cherokeega.org](http://cherokeega.org)



**Cherokee By Choice**

*Experience*

**GIBBS GARDENS**

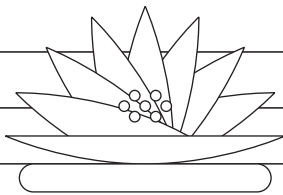
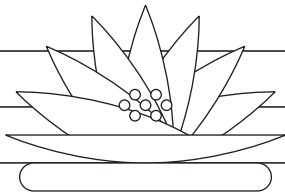

[cherokeega.org](http://cherokeega.org)

**Color and Share**

Reveal your masterpieces on social media using the hashtag **#cherokeebychoice**

Presented By **CHEROKEE OFFICE OF ECONOMIC DEVELOPMENT** | [cherokeega.org](http://cherokeega.org)

**Cherokee By Choice**

*Enjoy the*

**ATLANTA YACHT CLUB**

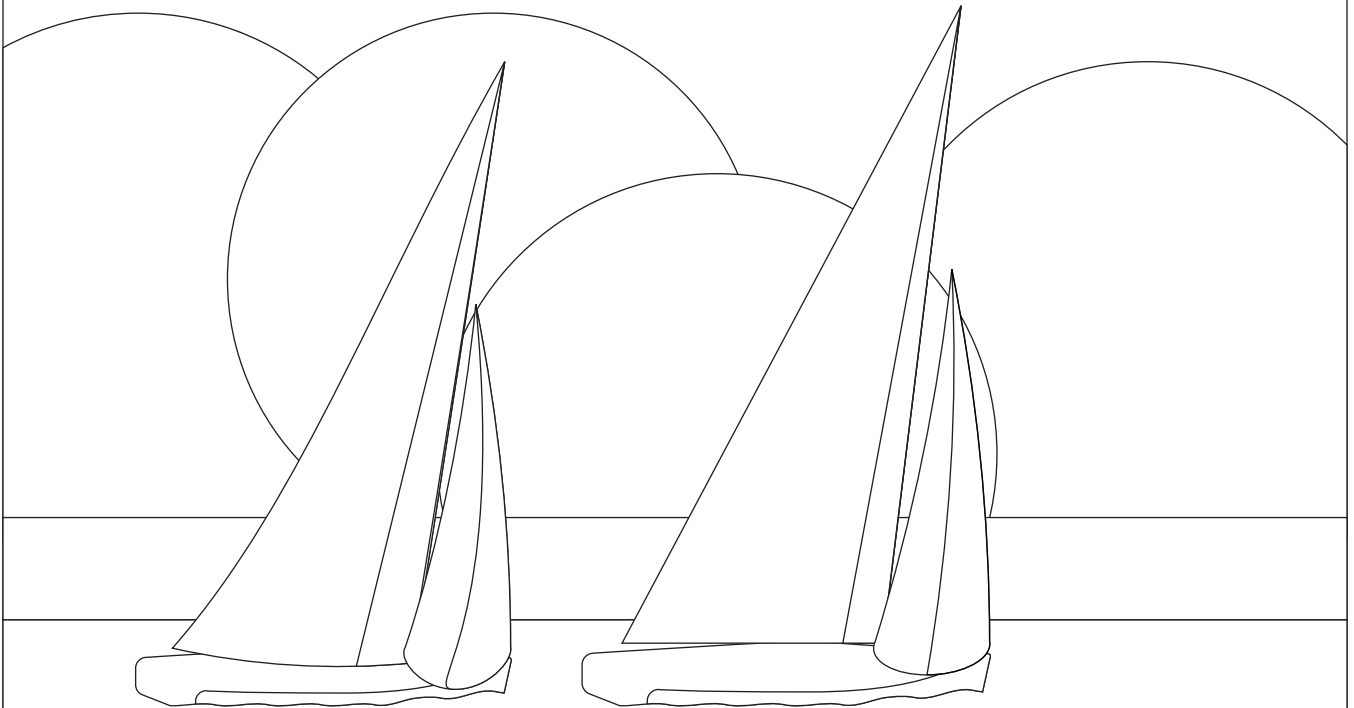

[cherokeega.org](http://cherokeega.org)

**Color and Share**

Reveal your masterpieces on social media using the hashtag **#cherokeebychoice**

Presented By **CHEROKEE OFFICE OF ECONOMIC DEVELOPMENT** | [cherokeega.org](http://cherokeega.org)

This is a modern take on Cherokee’s natural beauty. Experience the stunning view of the Etowah River on Canton’s pedestrian bridge connecting Etowah River Park and Heritage Park. Grab a tube or canoe and drop in at the Parrie Jean Pinyan Canoe Launch and float down the river to The Mill on Etowah.

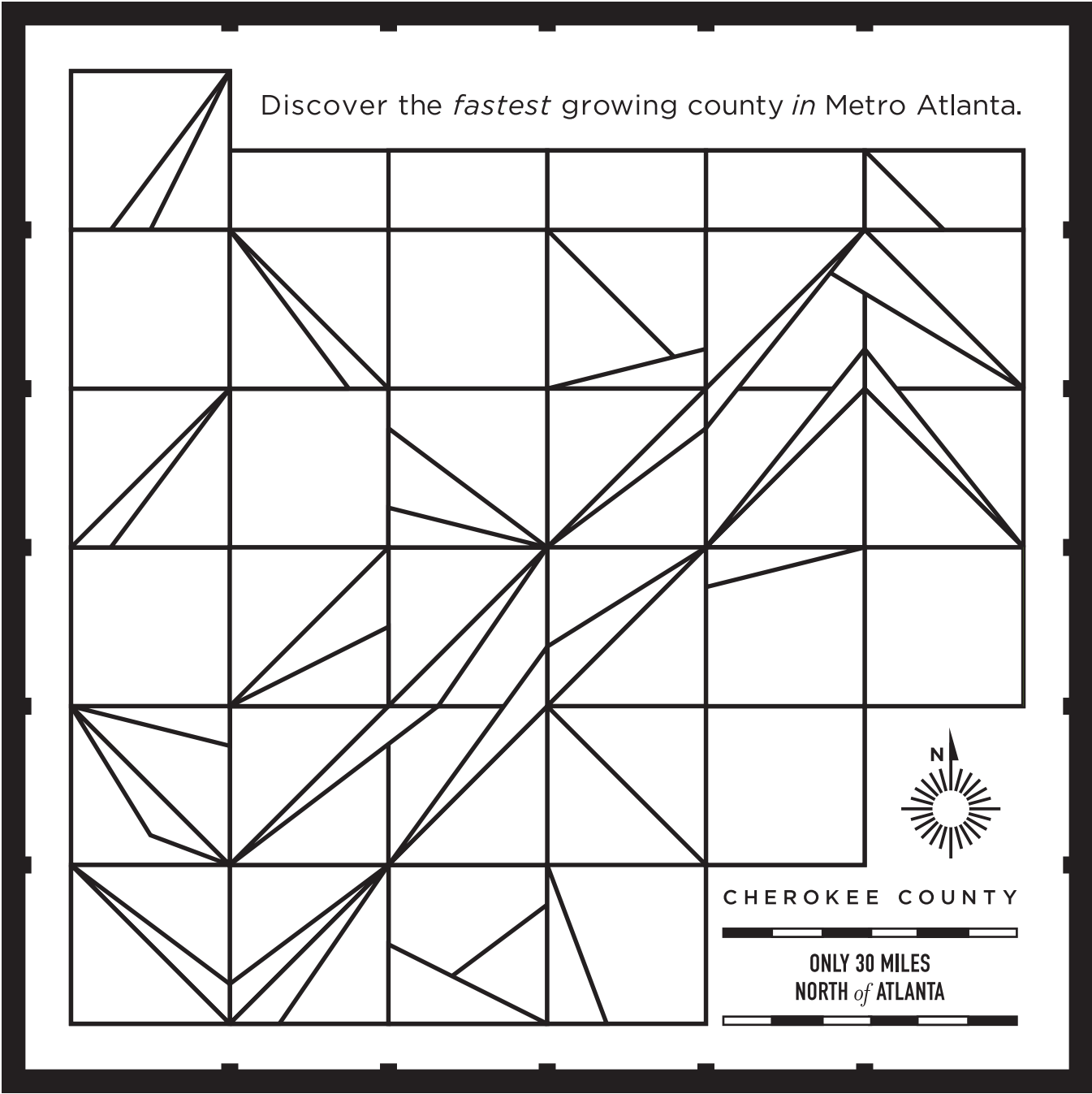

## ABSTRACT ART MAP OF CHEROKEE COUNTY AND ETOWAH RIVER

### Color and Share

Reveal your masterpieces on social media using the hashtag **#cherokeebychoice**

Presented By CHEROKEE OFFICE OF ECONOMIC DEVELOPMENT | [cherokeega.org](http://cherokeega.org)

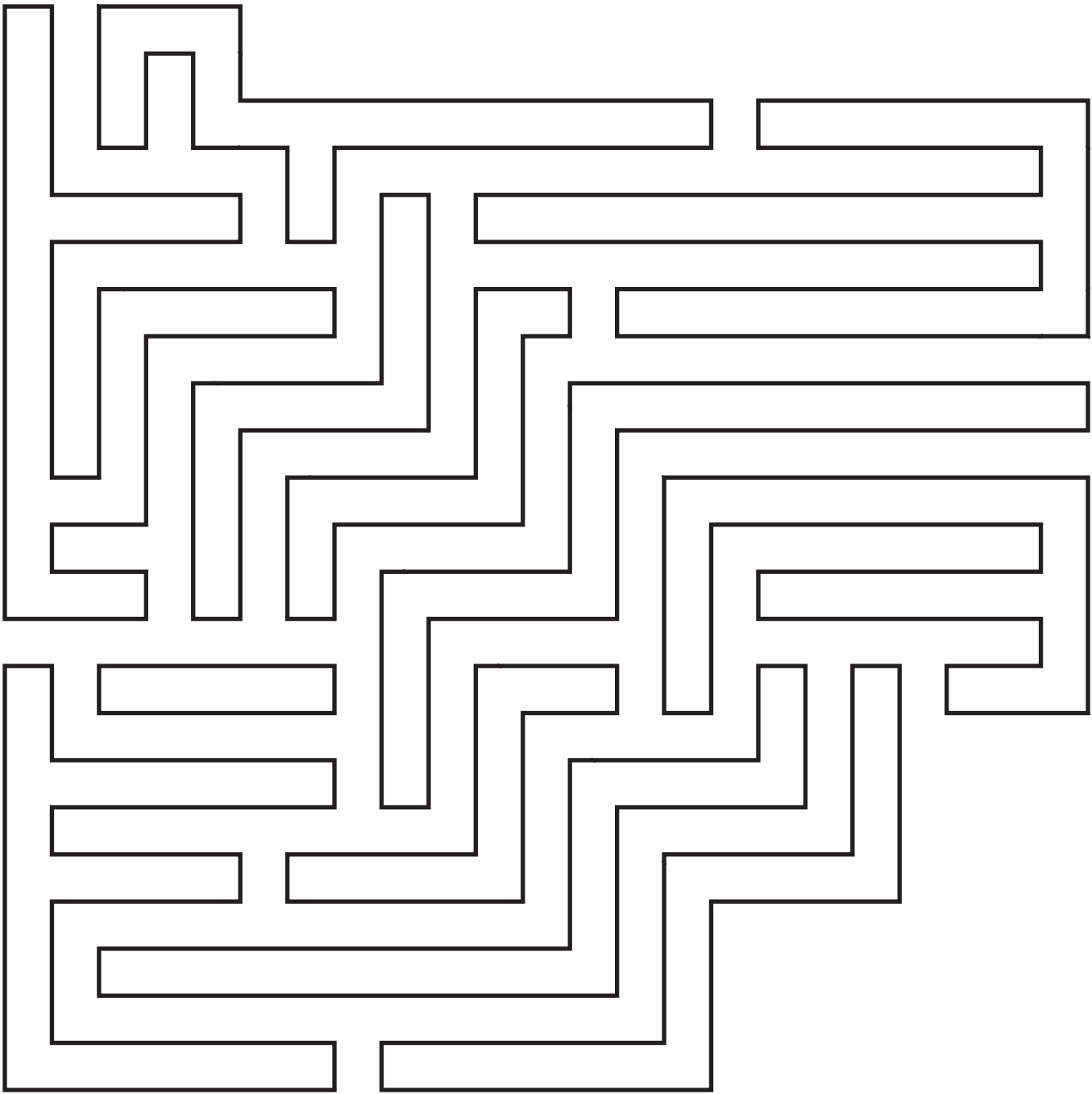

**CHEROKEE COUNTY | A MAZE OF OPPORTUNITY**

**Color and Share**

Reveal your masterpieces on social media using the hashtag **#cherokeebychoice**

Presented By **CHEROKEE OFFICE OF ECONOMIC DEVELOPMENT** | [cherokeega.org](http://cherokeega.org)



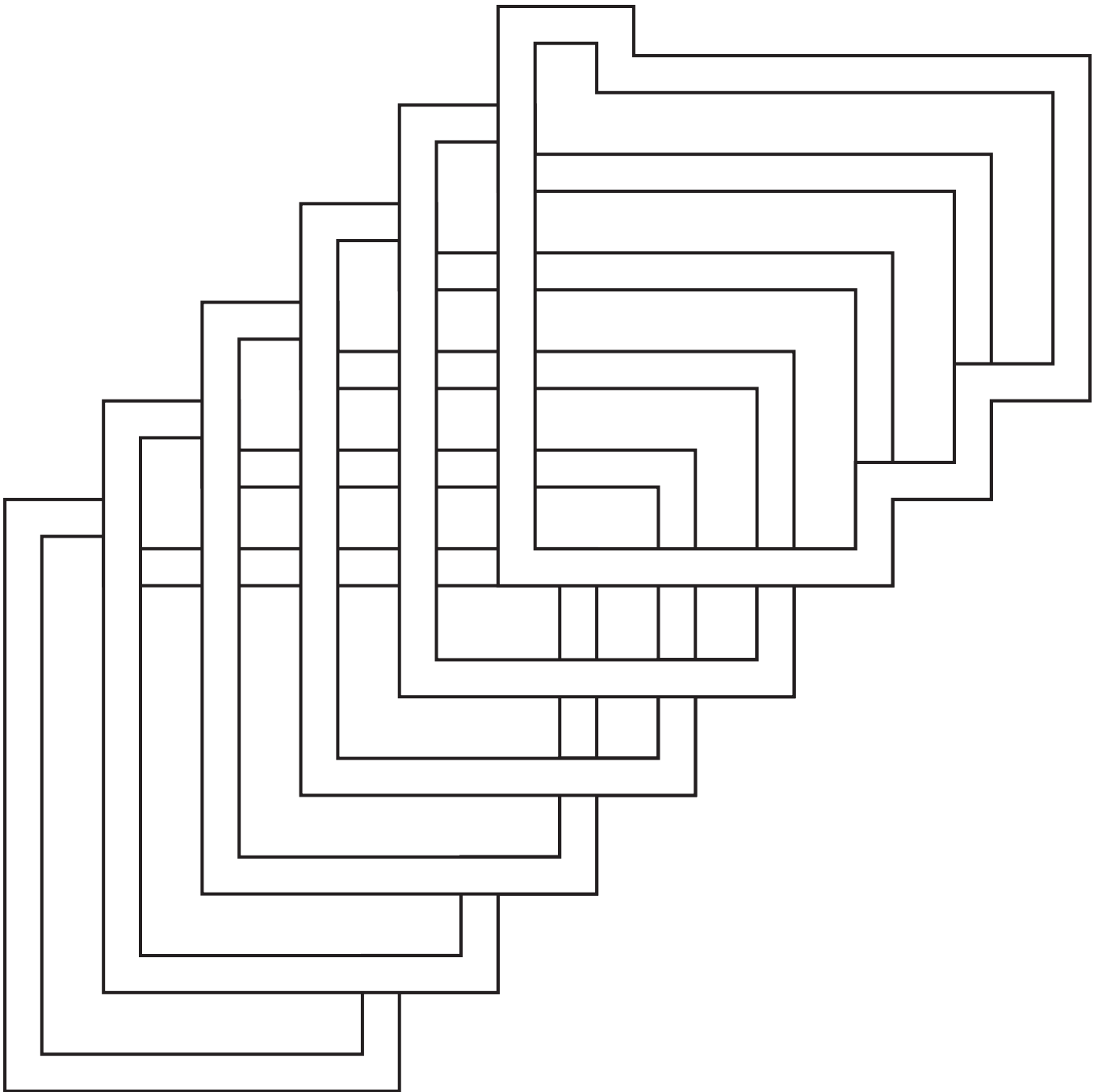

**CHEROKEE COUNTY | FASTEST GROWING COUNTY IN METRO ATLANTA**

**Color and Share**

Reveal your masterpieces on social media using the hashtag **#cherokeebychoice**

Presented By **CHEROKEE OFFICE OF ECONOMIC DEVELOPMENT** | [cherokeega.org](http://cherokeega.org)

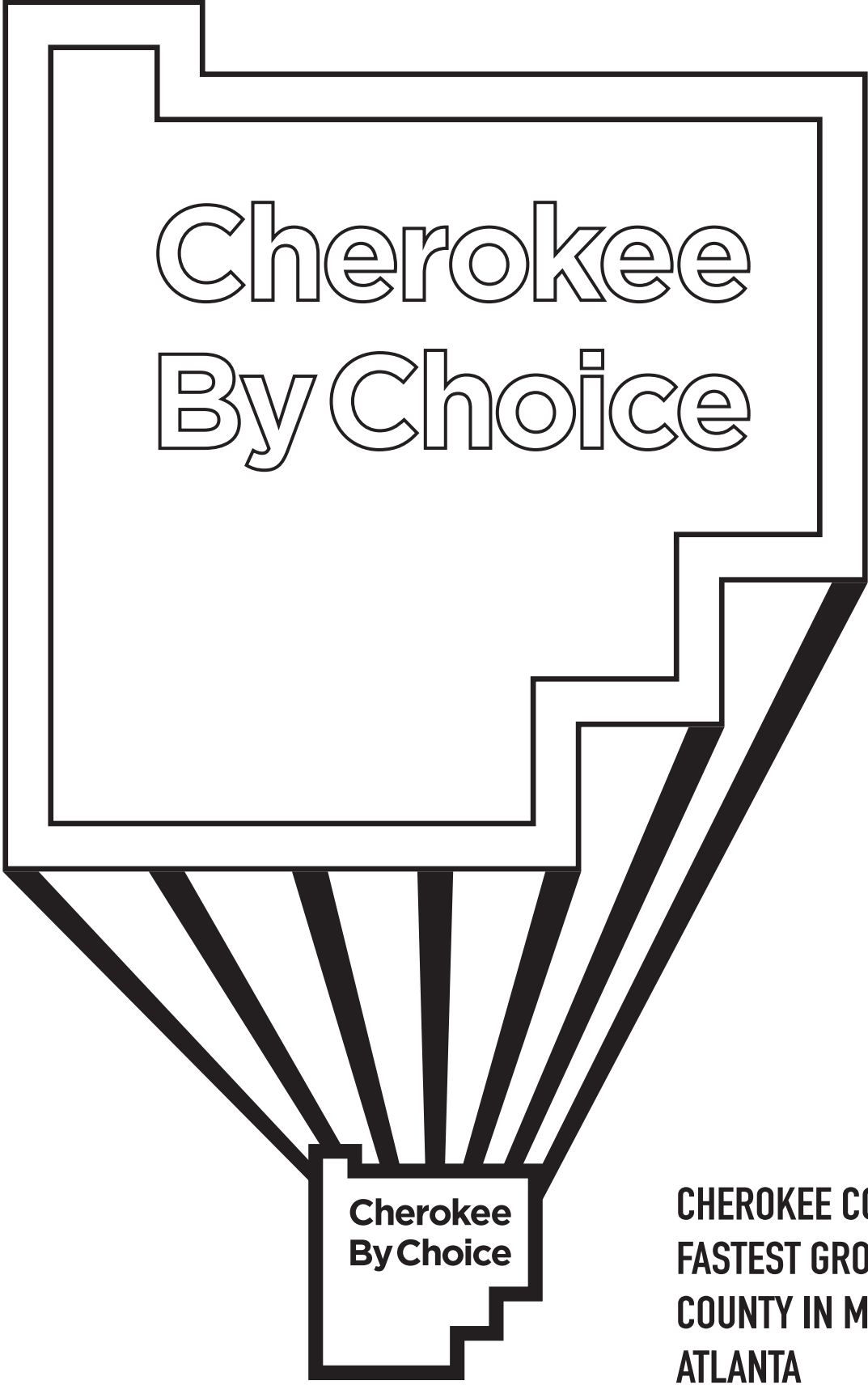

Cherokee  
By Choice

Cherokee  
By Choice

CHEROKEE COUNTY  
FASTEST GROWING  
COUNTY IN METRO  
ATLANTA

**Color and Share**

Reveal your masterpieces on social media using the hashtag **#cherokeebychoice**

Presented By **CHEROKEE OFFICE OF ECONOMIC DEVELOPMENT** | [cherokeega.org](http://cherokeega.org)

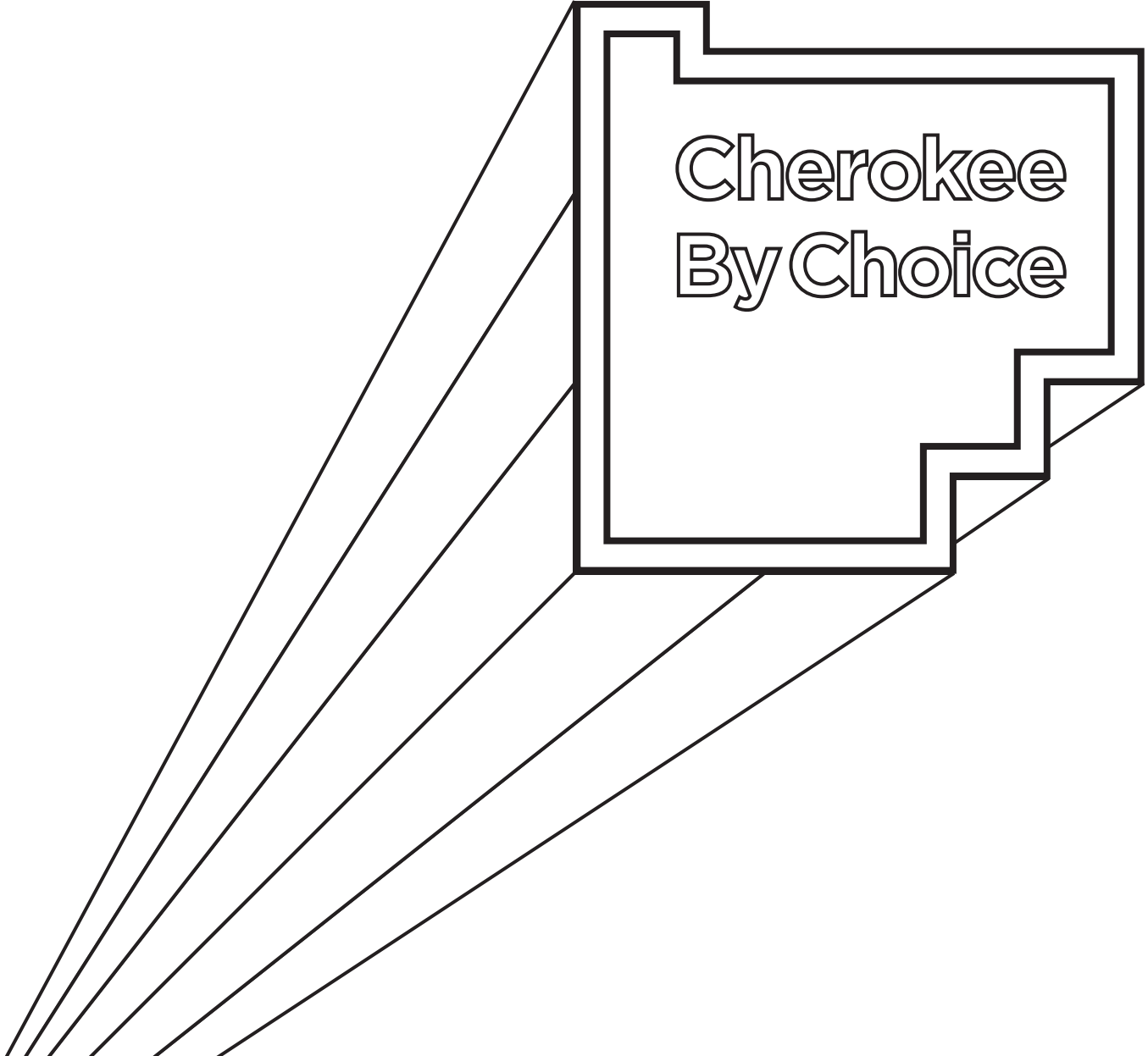

Cherokee  
By Choice

---

**CHEROKEE COUNTY | FASTEST GROWING COUNTY IN METRO ATLANTA**

**Color and Share**

Reveal your masterpieces on social media using the hashtag **#cherokeebychoice**

Presented By **CHEROKEE OFFICE OF ECONOMIC DEVELOPMENT** | [cherokeega.org](http://cherokeega.org)





# Cherokee By Choice

**CHEROKEE COUNTY | FREEFORM | WAVES**

**Color and Share**

Reveal your masterpieces on social media using the hashtag **#cherokeebychoice**

Presented By **CHEROKEE OFFICE OF ECONOMIC DEVELOPMENT** | [cherokeega.org](http://cherokeega.org)



# Cherokee By Choice

**CHEROKEE COUNTY | FREEFORM | COUNTY LINES**

**Color and Share**

Reveal your masterpieces on social media using the hashtag **#cherokeebychoice**

Presented By **CHEROKEE OFFICE OF ECONOMIC DEVELOPMENT** | [cherokeega.org](http://cherokeega.org)



# Cherokee By Choice

**CHEROKEE COUNTY | FREEFORM | MAKE YOUR OWN!**

**Color and Share**

Reveal your masterpieces on social media using the hashtag **#cherokeebychoice**

Presented By **CHEROKEE OFFICE OF ECONOMIC DEVELOPMENT** | [cherokeega.org](http://cherokeega.org)

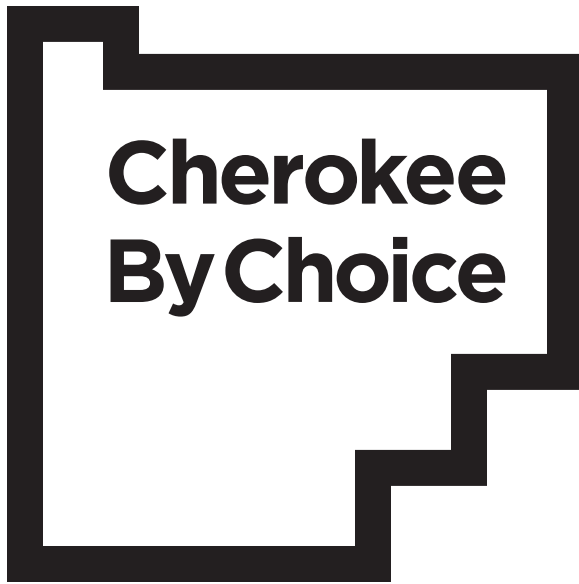

# Coloring Book

Presented By



CHEROKEE | ECONOMIC  
OFFICE OF | DEVELOPMENT

Design and Illustrations by:



**TOM COX DESIGN STUDIO** / with contributions from Taryn Cox